

**EngA**<sup>®</sup>

**ENGINEERED AIR**<sup>®</sup>

**INSTALLATION, OPERATION  
AND MAINTENANCE MANUAL**

**FOR**

**DJ(E,S) & DG SERIES**

**INDIRECT GAS OR OIL FIRED HEATING UNITS**

**INDOOR AND OUTDOOR MODELS**



**Intertek**



**Intertek**

UNIT MODEL NO. \_\_\_\_\_  
UNIT SERIAL NO. \_\_\_\_\_  
SERVICED BY: \_\_\_\_\_  
TEL. NO: \_\_\_\_\_

**CANADIAN  
HEAD OFFICE  
AND FACTORY**

1401 HASTINGS CRES. SE  
CALGARY, ALBERTA  
T2G 4C8  
Ph: (403) 287-4774  
Fx: 888-364-2727

**USA  
HEAD OFFICE  
AND FACTORY**

32050 W. 83<sup>rd</sup> STREET  
DESOTO, KANSAS  
66018  
Ph: (913) 583-3181  
Fx: (913) 583-1406

**CANADIAN  
EASTERN FACTORY**

1175 TWINNEY DRIVE  
NEWMARKET, ONTARIO  
L3Y 5V7  
Ph: (905) 898-1114  
Fx: (905) 898-7244

**SALES OFFICES ACROSS CANADA AND USA**

Retain instructions with unit and maintain in a legible condition.  
Please give model number and serial number when contacting  
factory for information and/or parts.

[www.engineeredair.com](http://www.engineeredair.com)

May 12 R2

**TABLE OF CONTENTS**

YOU HAVE RESPONSIBILITIES TOO.....	3
INTRODUCTION .....	3
SAFETY PRECAUTIONS.....	3
WARRANTY .....	4
PARTS.....	5
RECEIVING .....	5
TEMPORARY STORAGE .....	5
INSTALLATION .....	6
CODES.....	6
MINIMUM CLEARANCE TO COMBUSTIBLES AND FOR SERVICE IN INCHES (mm).....	7
LIFTING.....	8
MOUNTING .....	8
SHIPPING MATERIALS .....	9
ASSEMBLY .....	9
PIPING, ELECTRICAL OR CONTROL SERVICE CONNECTIONS.....	10
NATURAL GAS AND PROPANE INSTALLATION: .....	10
GAS LINE TESTING (EXTERNAL TO THE UNIT).....	11
OIL INSTALLATION .....	11
HEAT EXCHANGER CONDENSATE DRAIN ON INDOOR UNITS .....	11
VENTING PRODUCTS OF COMBUSTION .....	12
DUCT FURNACE INSTALLATION.....	13
PIPING, ELECTRICAL OR CONTROL SERVICE CONNECTIONS.....	13
ELECTRICAL INSTALLATION .....	13
Recommended 24V Field Wiring Size: .....	14
DUCT MOUNTED TE-6000-EA3 TEMPERATURE SENSOR.....	15
COIL CONNECTIONS.....	15
DRAIN TRAPS.....	16
FLUSHING AND DEGREASING OF WATER AND GLYCOL COILS.....	16
HEAT TRANSFER FLUIDS .....	17
BEFORE START-UP .....	17
START-UP CHECK LIST.....	17
OPERATION .....	19
SAFETY SHUTOFF VALVE LEAK TEST: .....	20
GAS MANIFOLD.....	20
OPERATIONAL CHECK FOR ALL GAS FIRED DJ & DG UNITS.....	21
OPERATIONAL CHECK FOR ALL OIL FIRED DJ & DG UNITS .....	22
COMBUSTION AND FINAL UNIT CHECK FOR UNITS WITHOUT TRAC CONTROLS .....	23
ELECTRODE DETAIL .....	24
UNIT SHUT-DOWN INSTRUCTIONS .....	24
Service Shut Down .....	24
Emergency Shut Down.....	25
Start-Up After Extended Shut-Down Period.....	25
CONTROL SETTINGS .....	25
MAINTENANCE.....	25
ELECTRICAL .....	26
BELT ADJUSTMENT.....	26
SET SCREWS.....	27
BEARING SETSCREW TORQUES.....	27
LUBRICATION OF FAN BEARINGS.....	27
LUBRICATION OF DODGE FAN BEARINGS.....	28
MOTOR LUBRICATION .....	29
GAS MANIFOLD.....	30
GAS BURNERS.....	30
OIL BURNERS .....	30
VENT TERMINALS.....	30
FILTERS.....	30
CONTROLS.....	31
CONTROL ENCLOSURE VENTILATION .....	31
OUTDOOR AIR INTAKES, MIXING SECTIONS AND DAMPERS.....	31
COILS.....	31

## YOU HAVE RESPONSIBILITIES TOO

This installation, operation and maintenance manual can not cover every possibility, situation or eventuality. Regular service, cleaning and maintaining the equipment is necessary. If you are not capable of performing these tasks, hire a qualified service specialist. **Failure to perform these duties can cause property damage and/or harm to the building occupants and will void the manufacturers' warranty.**

## INTRODUCTION

Engineered Air units are high quality products designed and manufactured to provide many years of trouble-free operation. We recommend that this manual be read thoroughly to ensure proper installation, efficient operation and proper maintenance of this equipment. The submittal record is considered to be part of the Installation, Operation and Maintenance Manual. Please report any omissions to the national service manager.

## SAFETY PRECAUTIONS

Read, understand and follow the complete manual before beginning the installation, including all safety precautions and warnings.



### **FIRE OR EXPLOSION HAZARD**

**Failure to follow safety warnings exactly could result in serious injury, death or property damage.**

**Be sure to read and understand the installation, operation and service instructions in this manual.**

**Improper installation, adjustment, alteration, service or maintenance can cause serious injury, death or property damage.**



— **Do not store or use gasoline or other flammable vapors and liquids in the vicinity of this or any other appliance.**

#### **— WHAT TO DO IF YOU SMELL GAS**

- **Do not try to light any appliance.**
- **Do not touch any electrical switch; do not use any phone in your building.**
- **Leave the building immediately.**
- **Immediately call your gas supplier from a phone remote from the building. Follow the gas supplier's instructions.**
- **If you cannot reach your gas supplier, call the fire department.**

— **Installation and service must be performed by a qualified installer, service agency or the gas supplier.**

**Warning:**  Pool, laundry and common cleaning products often contain fluorine or chlorine compounds. When these chemicals pass through the heater, they can form strong acids. The acid can eat through the heat exchanger wall, causing serious damage and presenting a possible threat of flue gas spillage into the building.

**Warning:**   
 This unit is connected to high voltages. Electrical shock or death could occur if instructions are not followed. This equipment contains moving parts that can start unexpectedly. Injury or death could occur if instructions are not followed. All work should be performed by a qualified technician. Always disconnect and lock out power before servicing. DO NOT bypass any interlock or safety switches under any circumstances.

## WARRANTY

**LIMITED WARRANTY** ENGINEERED AIR will furnish without charge, F.O.B. factory, freight collect, replacement parts for, or repairs to products covered herein which prove defective in material or workmanship under normal and proper use for a period of twelve (12) months from the initial start-up or eighteen (18) months from the date of shipment, whichever expires sooner, provided the customer gives ENGINEERED AIR written notice of such defects within such time periods and provided that inspection by ENGINEERED AIR establishes the validity of the claim and all pertinent invoices have been paid in full. The repairs or replacements will be made only when the complete product(s) or part(s) claimed to be defective are returned to ENGINEERED AIR or a depot designated by ENGINEERED AIR, transportation charges prepaid. Repairs or replacements as provided for by this paragraph shall constitute fulfillment of all ENGINEERED AIR's obligations with respect to this warranty. The refrigerant charge is not included in any part of this warranty. This warranty does not apply to any products or parts thereof that have been subject to accident, misuse or unauthorized alterations, or where ENGINEERED AIR's installation and service requirements have not been met.

The foregoing warranty is in lieu of all other warranties, express or implied. ENGINEERED AIR specifically disclaims any implied warranty of merchantability and/or fitness for purpose. Under no circumstances shall ENGINEERED AIR be liable to, nor be required to indemnify, Buyer or any third parties for any claims, losses, labour, expenses or damages (including special, indirect, incidental, or consequential damages) of any kind, resulting from the performance (or lack thereof) of this Agreement or the use of, or inability to use the goods sold hereunder, including, but not limited to, damages for delay, temporary heating/cooling costs, loss of goodwill, loss of profits or loss of use. Furthermore, the parties agree that the Buyer's sole remedy under this Agreement shall be limited to the limited warranty set forth in the preceding paragraph relating to the repair or replacement of any defective goods. Under no circumstances shall any claim or award against ENGINEERED AIR exceed the original contract price whether awarded through arbitration, litigation or otherwise.

ENGINEERED AIR Warranty is void if:

1. The unit is not installed in accordance with this manual.
2. The start-up and operation of the unit is not performed in accordance with this manual.
3. The unit is operated in an atmosphere containing corrosive substances.
4. The unit is allowed to operate during building construction.
5. The unit is allowed to operate in atmospheres where chlorine or chlorine compounds are present or which contain any contaminant (silicone, aluminum oxide etc.) that adheres to the spark ignition flame sensing probe.

## PARTS

**Warning:** Any replacement part must be of equivalent listing or certification and be functionally equivalent. The replacement part must meet the original's specification in terms of functionality including certifications, timing, input and output range, accuracy and operation.

Failure to replace parts or components with equivalent parts can cause property damage, injury or death.



1. Motors:  
Motor manufacturers have service centers that will repair or replace motors as required.
2. Parts Other Than Motors:  
Contact the nearest Engineered Air sales office or factory. Be sure to include Model Number, Serial Number, date of installation and nature of failure along with the description of the parts required. Some parts may not be stocked items that must be made or ordered.

## RECEIVING

Refer to the back of the packing slip for receiving unit instructions.

On receipt of the unit, check for damage. Inspect protective covers for punctures or other signs that there may be internal damage. Remove protective covers and check for internal damage. Replace covers if the unit is not being assembled or installed at this time. Open access doors and check for internal damage. Close access doors when the inspection is complete.

All units are pre-tested at the factory immediately prior to shipping and are ensured to be in good operating condition at that time. If damage is found follow the instructions on the packing slip.

On receipt of the unit, check electrical characteristics (see rating plate) to make sure the unit voltage is compatible with that available for the unit. All parts for field installation are listed on the shipping order form.

## TEMPORARY STORAGE

If a unit is to be stored prior to installation the following precautions are required:

- Store in a well drained area that will not accumulate surface water.
- Store in an area where the unit will not get damaged.
- The entire perimeter and any full height cross members of the unit must be supported by a level surface and the supporting surface must be adequate for supporting the entire weight of the unit.
- All protective coverings that were provided for shipping must be in place.
- Protect indoor units from rain and snow.

**INSTALLATION****Warning:**

**Only equipment bearing a CSA C22.2 No. 213 or UL 1604 rating plate (label) with an accompanying CSA Certification mark is suitable for installation in a hazardous location. The hazardous location must conform with the Class, Division, Group and temperature code (if shown) displayed on the rating plate (label).  
If not marked as noted above, the unit is not rated for hazardous locations and should not be installed in areas requiring any hazardous location rating.**

**Caution:**

**All wiring, piping and fuel line installation must be completed by qualified persons in accordance with all federal, state, provincial and/or local codes.**

**Note: Installation shall be in accordance with this manual and all other associated component and control Installation, Operation and Maintenance Manuals.**

**CODES****In Canada:**

1. The installation of this unit shall be in accordance with the latest edition of the Canadian Electrical Code, Part 1 – C.S.A. Standard C22.1, Provincial and Local Codes, and in accordance with the local authorities having jurisdiction.
2. This unit shall be electrically grounded in accordance with the latest edition of the Canadian Electrical Code, Part 1 – C.S.A. Standard C22.1, Provincial and Local Codes, and in accordance with the local authorities having jurisdiction.
3. The installation of this unit shall be in accordance with the latest edition of the Canadian Natural Gas and Propane Installation Code, C.S.A. Standard B149.1, Provincial and Local Codes, and in accordance with the local authorities having jurisdiction.
4. In accordance with local authorities having jurisdiction or CSA. Standard B149.1 a readily accessible approved manual shut-off valve shall be installed in either the drop or riser as close as possible to the valve train (gas manifold).
5. The installation of this unit shall be in accordance with the latest edition of the National Plumbing Code of Canada, Provincial and Local Codes, and in accordance with the local authorities having jurisdiction.
6. The installation of this unit shall be in accordance with all other National, Provincial and Local Codes, and in accordance with the local authorities having jurisdiction.

**In USA:**

1. The installation of this unit shall be in accordance with the latest edition of the National Electrical Code (ANSI/NFPA 70), State and Local Codes and in accordance with the local authorities having jurisdiction.

2. This unit shall be electrically grounded in accordance with the latest edition of the National Electrical Code (ANSI/NFPA 70), State and Local Codes and in accordance with the local authorities having jurisdiction.
3. If the unit has not been provided with an electric disconnect switch, one of adequate ampacity shall be installed in accordance with Article 430 of the National Electrical Code (ANSI/NFPA 70).
4. The installation of this unit shall be in accordance with the latest edition of the National Fuel Gas Code ANSI/Z223.1/NFPA 54, State and Local Codes and in accordance with the local authorities having jurisdiction.
5. In accordance with local authorities having jurisdiction or NFPA 54 an accessible approved manual shutoff valve shall be installed within 6 ft (1.8 m) of the valve train (gas manifold).
6. The installation of this unit shall be in accordance with the latest edition of the National Standard Plumbing Code (NSPC), State and Local Codes and in accordance with the local authorities having jurisdiction.
7. The installation of this unit shall be in accordance with all other National, State and Local Codes, and in accordance with the local authorities having jurisdiction.

**MINIMUM CLEARANCE TO COMBUSTIBLES AND FOR SERVICE IN INCHES (mm)**

MODEL	COMBUSTIBLE CLEARANCE						SERVICE CLEARANCE		
	TOP	FRONT	BACK	SIDE	BOTTOM	FLUE	OPPOSITE BURNER SIDE	SERVICE/ BURNER SIDE	CONTROL PANEL †
<b>DJ(E,S) INDIRECT FIRED GAS HEAT</b>	6" (152)	6" (152)	6" (152)	1" (25)	0	9" (229)	NA	24" (610)	42" (1067)
<b>DG INDIRECT FIRED GAS HEAT</b>	6" (152)	6" (152)	6" (152)	1" (25)	0	9" (229)	NA	24" (610)	42" (1067)
<b>INDIRECT FIRED OIL HEAT</b>	6" (152)	6" (152)	6" (152)	1" (25)	0	9" (229)	18" (457)	24" (610)	42" (1067)
<b>FLUID COILS &amp; RECOVERY DEVICES</b>	1" (25)	1" (25)	1" (25)	1" (25)	0	NA	NA	UNIT WIDTH	42" (1067)
<b>ELECTRIC HEAT</b>	1" (25)	1" (25)	6" (152)	1" (25)	0	NA	NA	UNIT WIDTH + 10" (254)	42" (1067)
<b>OTHER (NON GAS) UNITS</b>	1" (25)	1" (25)	1" (25)	1" (25)	0	NA	NA	24" (610)	42" (1067)

† - As required by the Canadian Electrical Code or the National Electrical Code.

For Safety and Service, the minimum clearances must be observed. Minimum clearances also provide adequate combustion air supply.

## LIFTING

Engineered Air units are constructed on a structural steel base frame. The unit base frame is equipped with lifting lugs specifically located to facilitate proper lifting of the unit. Spreader bars must be used to keep rigging away from the unit cabinetry. All lifting lugs must be used. If using a lift truck, **ONLY** lift using the perimeter structural frame. **DO NOT** allow forks to lift on cabinet or unit floor.

Note: There may be bottom mounted components, such as drain piping, that can be easily damaged.

### **Warning:**



**Injury or death can result from improper rigging and lifting. Rigging and lifting of equipment must be performed by qualified personnel with proper equipment using appropriate and approved safety precautions.**

## MOUNTING

Units must be mounted level. Failure to do so can cause water to be trapped in drain pans or operational problems that can void warranty. Failure to do so can result in injury or death, damage the equipment and/or building and can be a cause of poor indoor air quality.

Equipment must be installed so that sufficient working clearance and component access is provided. Some units are designed for cantilevered installation. Consult the Submittal Record for specific unit mounting.

Consult the Submittal Record for specific unit mounting. Engineered Air units are constructed for three types of mounting:

1. Base mounting – Consult the Submittal Record for type of mounting. Unless the unit is specifically designed for point or other mounting, the base of the unit must be supported continuously by a mounting support system that is directly below the unit structural base frame and runs the entire length and width of the unit. Refer to the Submittal Record for mounting information. Units 100” (2500mm) wide and under can be supported on each side continuously along the length of the unit. As a minimum, sleepers that are installed perpendicular to the length of the unit must be continuous across the width of the unit and shall be installed at the end lifting point base rails and the lesser of 80” (2000mm) on center or at all lifting points.
2. Suspended mounting – Where units have been designed for suspended mounting, factory provided connections for hanger rods will be provided. All hanger rod supports must be used. Suspended units must be protected from damage. When installed in aircraft hangers, parking garages or repair garages the installation must comply where applicable with:
  - a) The Canadian Natural Gas and Propane Installation Code, C.S.A. Standard B149.1
  - b) The Standard on Aircraft Hangers, ANSI/NFPA 409
  - c) The Standard on Parking Garages, ANSI/NFPA 88A
  - d) The Standard on Repair Garages, ANSI/NFPA 88B
3. Roof curb mounting – The curbs are constructed of heavy gauge load bearing, galvanized steel, and must be fully insulated after installation. Wood nailer strips are provided for easy attachment of roof flashing. Gasket material is supplied with the unit and must be field mounted on the curb to seal the joint between the curb and the unit frame. The curb must be supported along its entire perimeter and any full height cross members as shown on the shop drawings. Point loading of curbs is not permissible.



The gasket material provided for the curb is closed cell foam. Closed cell foam is dense and does not compress easily. If the unit is split and shipped in sections there will also be gasket material for sealing between sections. The gasket material for splits is open cell foam. It is less dense than the closed cell foam and compresses easily.

**ONLY USE THE CLOSED CELL FOAM GASKET PROVIDED FOR SEALING THE CURB.**

Curbs may be broken down for shipping. Field assembly is required by the installing contractor. Bolt all sections together at split joints using hardware provided. The installing contractor must caulk and seal all joint and corner flashings. All flashings and braces that are provided must be installed. **DO NOT** screw/penetrate joint, corner or adaptor flashings. Refer to assembly instructions sent with roof curb.

## SHIPPING MATERIALS

Remove shipping materials. Shipping materials may include, but are not limited to:

- Protective covers over openings, inlets, condenser coils etc.
- Protective covers over split sections if provided.
- Tie-down bolts, straps and blocks on fan and compressor vibration isolators.
- Tie-down bolts, straps and blocks on tilt equipped heat pipes and enthalpy/desiccant wheels if supplied.
- Indirect fired heat exchangers may be supported with wood for shipping. Remove.

## ASSEMBLY

**Warning:** **Assembly of split units requires bolting together the base frame of adjacent sections. This may require personnel to work under the unit during assembly. Injury or death can result from improper support or improper loading of the curb. Additional temporary support shall be provided by the installer for the safety of personnel.**



If the unit is split and shipped in sections, the sections must be field assembled. All sections are pre-drilled for assembly. The hardware and gaskets are packed in one of the sections. Apply the gasket, align the sections. The base frame must be bolted together first. Access below the unit for bolting of the base frame must be provided. Once the base frame has been tightly fastened, loosely assemble all the bolts and nuts, and then tighten. Caulk all split lines. Install split joint caps. The inlet hood is designed for field installation. On outdoor units connect the hood to the support flange and attach with appropriate fasteners. Connect all wiring on units that had been split for shipment.

The gasket material provided for the split is open cell foam. Open cell foam is light and compresses easily. If the unit is mounted on a curb provided by Engineered Air there will also be gasket material for sealing the curb. The gasket material for curbs is closed cell foam. It is more dense than open cell foam and does not compress as easily.

**ONLY USE THE OPEN CELL FOAM GASKET PROVIDED FOR SEALING THE SPLIT(S).**

## SPLIT UNIT WIRING

All split wiring must be completed by an electrician prior to starting the equipment. A number of different methods are used to reconnect the wiring.

Power wire: this wiring is generally not broken or spliced, and will extend from the device back to the contactor or terminal block inside the electrical panel(s). The wire will be tagged to identify which panel it extends to and will be numbered to the corresponding connection.

The location of the equipment split line may result in the wire being disconnected at the device it is feeding. The wire bundle will be tagged and identified. Confirm correct rotation of 3 phase devices after the wiring connections has been completed.

Control wire: this wire is typically broken near the split line, to be reconnected at either a enclosed terminal block, junction box or extended to a nearby control panel. Each wire or wire bundle will be tagged and numbered to indicate the location it is sent to.

Sensor wire shield: The drain wire from the shield must be grounded (at one end only). A ground connection point is available for connection at the point of termination.

All loose wiring must be securely fastened to the equipment casing upon completion.

### PIPING, ELECTRICAL OR CONTROL SERVICE CONNECTIONS

**DO NOT install anything that will interfere with equipment access or the rating plate.**

Engineered Air equipment is constructed with cabinet and floors designed to prevent water from entering the building through the installed unit. When ordered, factory installed pipe chases and/or electrical chases are built into the unit floor. Factory chases are provided with covers that need to be replaced and sealed after piping and electrical connections are made.

**THE FLOOR OF THE UNIT HAS BEEN MADE WATER-RESISTANT. DO NOT CUT OR DRILL HOLES IN THE FLOOR OR USE PENETRATING FASTENERS.**

**All penetrations through the unit walls must be caulked and sealed to prevent air and/or water from entering the unit.**

### NATURAL GAS AND PROPANE INSTALLATION:

1. Installation must be made in accordance with the requirements of the authorities having jurisdiction.
2. Check the unit rating plate and confirm fuel type, supply pressure, input rating and temperature rise.
3. Refer to the heater rating plate for determining the minimum gas supply pressure for obtaining the maximum gas capacity for which this heater is specified.
4. Gas supply pressure higher than the unit rating plate requires an additional field supplied gas regulator.
5. Install an approved appliance shutoff valve on the gas supply in accordance with the requirements of the authorities having jurisdiction.
6. Gas lines shall not interfere with unit access. The gas line connection at the heater shall have an approved drip leg with screwed cap.
7. A minimum 1/8 inch NPT plugged tapping, accessible for test gauge connection, must be installed immediately upstream of the gas supply connection to the unit.
8. On indoor units any control device (regulator, diaphragm valve, high and low pressure switch, etc.) that requires a bleed or vent line, must be vented in accordance with applicable codes.

### GAS LINE TESTING (EXTERNAL TO THE UNIT)

The appliance and its individual shutoff valve must be disconnected from the gas supply piping system during any testing of that system at test pressures in excess of 0.5 psi (3.5 kPa).

The appliance must be isolated from the gas supply system by closing its individual shutoff valve during any testing of that system at test pressure equal to or less than 0.5 psi (3.5 kPa).

### OIL INSTALLATION

Installation must be made in accordance with NFPA 31 or CSA B139 and with the requirements of authorities having jurisdiction.

1. Check the unit name plate and confirm fuel type and input rating.
2. The heaviest fuel oil type is marked on the unit name plate.
3. The unit is to be supplied with an adequate flow of clean, air free fuel oil at a minimum temperature of 32°F (0°C) at a neutral pressure. This requirement can be met if the oil is supplied to the unit from an indoor day tank with a gravity supply.
4. All oil piping to the heater must be installed in accordance with good piping practices. (See supplemental piping information bulletin from the burner manufacturer).
5. All oil burners should have an oil return line.
6. **Oil fired heaters MUST use "A" vent.**
7. **OIL-FIRED APPLIANCES SHALL BE CONNECTED TO VENTS HAVING SUFFICIENT DRAFT AT ALL TIMES TO ENSURE SAFE AND PROPER OPERATION OF THE APPLIANCE.**

### HEAT EXCHANGER CONDENSATE DRAIN ON INDOOR UNITS

The drain must be installed in accordance with all plumbing codes.

The condensate is to be drained with minimum 1/2" (13 mm) nominal drain line, of material suitable for corrosive condensate, to an indirect drain connection.

## VENTING PRODUCTS OF COMBUSTION

Installation shall be in accordance with the requirements of authorities having jurisdiction and ANSI Z2231/NFPA 54 or CSA B149.1. Heaters must be provided with sufficient combustion air and shall not be located in an area where a negative pressure will be created that will starve the burner of combustion air. Flue outlet pressure must not exceed maximum over fire pressure shown on the nameplate.

Do not connect the vent to any portion of mechanical draft systems that are under positive pressure. Do not install dampers or other restrictive devices in the flue vent pipe.

Vent terminations shall be in accordance with the requirements of the authorities having jurisdiction.

The vent shall be installed in such a manner that access to the appliance or unit rating plate is not obstructed.

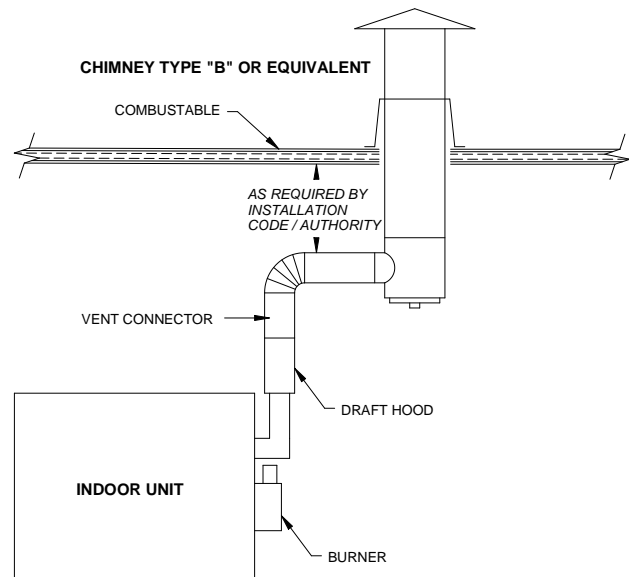

### Indoor

1. A vertical chimney must be certified "A" or "L" or equivalent type on units without draft hoods. Type "B" vent is acceptable on units with Engineered Air draft hoods. The vent size shall be selected from appropriate approved Vent Table.

**Note: Oil fired heaters MUST use "A" vent.**

2. A vent connector shall be of approved material and installation. It shall have a minimum clearance of 9" (229 mm) to combustible material. All horizontal portions of the venting system shall be supported to prevent sagging. All horizontal runs shall have a minimum rise of 2% in the direction of discharge. Horizontal vents shall be properly supported.
3. Units without draft hoods shall have individual chimneys.
4. This appliance shall not be connected to any portion of a mechanical draft system operating under positive pressure.
5. See separate Supplemental Installation Instructions for units that have side wall venting.

### Outdoor

Where appropriate, Engineered Air outdoor vent terminations may be provided. Two styles are shown below. The standard vent termination on the left and the old style vertical termination on the right. Attach the vent termination securely to the unit casing using #8 X 5/8" (minimum) sheet metal screws with washers at all holes provided. Horizontal clearance to obstructions is 24" (600mm) for the standard vent termination. Flue gases may discolor or damage adjacent surfaces. Vent terminations must not be under structures or building overhangs.

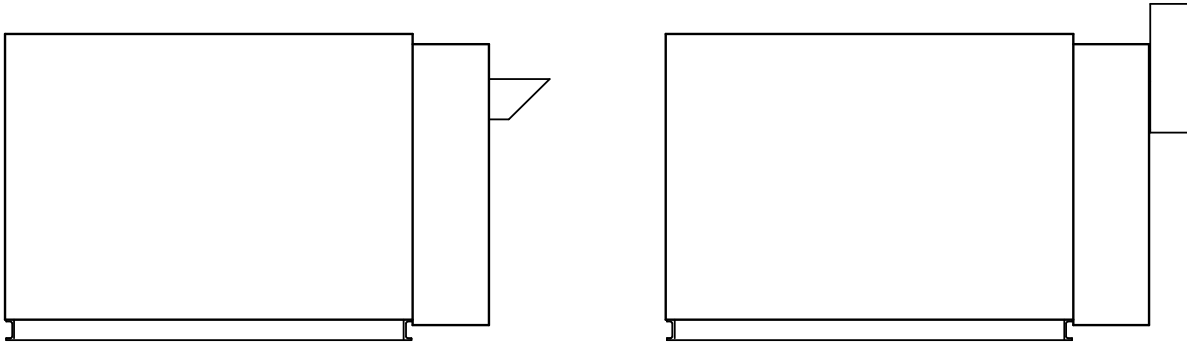

When the chimney and flue cap are provided by others, install in accordance with the instructions for the chimney and flue cap and to the requirements of the authorities having jurisdiction. The chimney shall have a temperature rating equivalent to “A” vent and be suitable for outdoor installation. Support the chimney independent of the unit.

### DUCT FURNACE INSTALLATION

A Duct Furnace is an indirect fired furnace without the fan. If a duct furnace is connected to a return air duct or any other inlet air restriction, the duct furnace shall be installed on the positive pressure side of the air-circulating fan. The airflow at the heater shall be suitably measured and shall be adjusted to within  $\pm 10\%$  of the stated airflow on the nameplate.

Duct Furnaces shall be installed with inlet duct that provides air distribution equivalent to a straight run of duct having the same cross-sectional area as the inlet connection and not less than 2 equivalent diameters in length.

Removable air tight access panels shall be provided on both the upstream and downstream sides of the duct furnace. The access panels shall be accessible when the appliance is installed for service and shall be sized to allow observation of smoke or light inside the casing to indicate the presence of leaks in the heat exchanger.

### PIPING, ELECTRICAL OR CONTROL SERVICE CONNECTIONS

**DO NOT install anything that will interfere with equipment access or the rating plate.**

Engineered Air equipment is constructed with cabinet and floors designed to prevent water from entering the building through the installed unit. When ordered, factory installed pipe chases and/or electrical chases are built into the unit floor. Factory chases are provided with covers that need to be replaced and sealed after piping and electrical connections are made.

**THE FLOOR OF THE UNIT HAS BEEN MADE WATER-RESISTANT. DO NOT CUT OR DRILL HOLES IN THE FLOOR OR USE PENETRATING FASTENERS.**

**All penetrations through the unit walls must be caulked and sealed to prevent air and/or water from entering the unit.**

### ELECTRICAL INSTALLATION

**DO NOT install anything that will interfere with equipment access or the rating plate.**

The unit must be electrically grounded and all wiring must be installed in accordance with the National Electrical Code, ANSI/NFPA 70, and/or the Canadian Electric Code CSA 22-1 and to the approval of the authorities having jurisdiction. **THE FLOOR OF THE UNIT HAS BEEN MADE WATER-RESISTANT. DO NOT CUT OR DRILL HOLES IN THE FLOOR OR USE PENETRATING FASTENERS.** Field wiring diagrams, internal wiring diagrams and operating functions are included in the control cabinet. The power requirements are indicated on the rating plate. Where field wiring of control circuits is required, take care to size the field wiring for a maximum 10% voltage drop. The control circuit ampacity is noted on the field wiring diagram. See the field wiring diagram for requirements for shielded or twisted pair wire for solid state devices.

<p><b>Caution:</b></p> 	<p><b>Temporary Power Generation</b></p> <p>The warranty will be void if the voltage being fed from any temporary generator is not within 10% of the nominal rated nameplate voltage and voltage imbalance shall be limited to 2%. A power monitor shall be installed by others to properly monitor power quality and conditions.</p> <p>All generator sets shall be provided with overcurrent and earth-fault protection. The protective apparatus should be capable of interrupting, without damage, any short-circuit current that may occur.</p>
--	--

<p><b>Warning:</b></p> 	<p>No unspecified external load shall be added to the control transformer circuit(s) or to the main power circuit(s).</p>
---	---

**Recommended 24V Field Wiring Size:**

Copper conductors only

Circuit Load (Amps) (1)	Maximum Total Length of Run									
	< 50 Ft (~ 15 m)	< 100 Ft (~ 30 m)	< 150 Ft (~ 45 m)	< 200 Ft (~ 60 m)	< 250 Ft (~ 75 m)	< 300 Ft (~ 90 m)	< 350 Ft (~ 105 m)	< 400 Ft (~ 120 m)	< 450 Ft (~ 135 m)	< 500 Ft (~ 150 m)
1	16 AWG	16 AWG	16 AWG	16 AWG	16 AWG	16 AWG	14 AWG	14 AWG	14 AWG	12 AWG
2	16 AWG	16 AWG	16 AWG	14 AWG	12 AWG	12 AWG	12 AWG	10 AWG	10 AWG	10 AWG
3	16 AWG	16 AWG	14 AWG	12 AWG	12 AWG	10 AWG	10 AWG	10 AWG		
4	16 AWG	14 AWG	12 AWG	10 AWG	10 AWG	10 AWG				
5	16 AWG	12 AWG	12 AWG	10 AWG						
6	16 AWG	12 AWG	10 AWG	10 AWG						
7	14 AWG	12 AWG	10 AWG							
8	14 AWG	10 AWG	10 AWG							
9	14 AWG	10 AWG								
10	12 AWG	10 AWG								
11	12 AWG	10 AWG								
12	12 AWG	10 AWG								
13	12 AWG									
14	12 AWG									
15	12 AWG									

Notes:

- 1) The field wiring load depends on the actual load on a particular control circuit the field wiring is connected to. Refer to the internal wiring diagram of the unit.
- 2) The table above is based on a maximum 10% voltage drop on a 24V control circuit. Wire size was calculated using the following formula:

$$CM = (25 \times I \times L) / V$$

Where **CM** is circular mils of conductor for a constant load of **I** amps, wire length **L** in feet from the unit to the field device and back, and voltage drop **V**.

When connecting to a three phase power supply, check for the correct rotation of all motors and fans. If the rotation is incorrect, reverse the rotation at the incoming power only. All electrical conduit outlets in the control panel must be sealed to prevent moist building air from migrating to the control panel.

**All penetrations through the unit walls must be caulked and sealed to prevent air and/or water from entering the unit.**

### DUCT MOUNTED TE-6000-EA3 TEMPERATURE SENSOR

Some applications require field installed discharge air sensors.

The sensor strip must be parallel to the air flow. The sensor should be mounted near the center of a straight duct 5 to 10 feet (1500 to 3000mm) downstream of the supply air connection to the Engineered Air unit. Avoid installing near duct transitions or elbows.

Use twisted pair or shielded wiring. The ground shield should be grounded only at the unit control panel end. Protect the opposite end ground and any unused wire with electrical tape.

When installing an Engineered Air TE-6000-EA3 duct mounted temperature sensor, the sensor strip must be parallel to the air flow as shown.

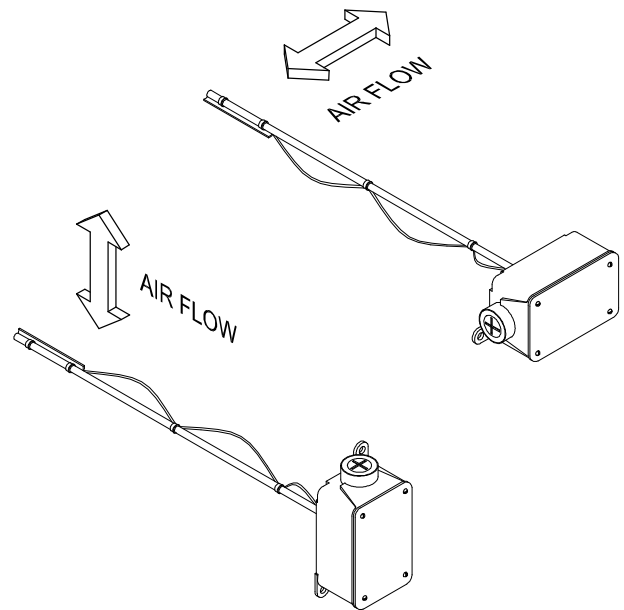

### COIL CONNECTIONS

This equipment may require field connection of water, steam or refrigerant coils. For proper operation airflow must be counterflow to the flow of the fluid. The inlet water connection is normally at the bottom of one header and the outlet water connection at the top of the other header. The steam connection is at the middle of the supply header and the condensate is at the bottom of the other header.

#### **Caution:**



**Use a backup wrench on threaded coil connections when installing piping.**

For refrigerant coils, all piping is to be installed by a qualified refrigeration mechanic. All refrigeration specialties shall be installed using good refrigeration installation and design practices.

Recovery, reuse, recycling, reclamation, and safe disposal of refrigerant is the only acceptable practice today. Venting of refrigerant into the atmosphere during installation or servicing is unacceptable. To avoid damage, use an accepted refrigerant recovery system whenever removing refrigerant. When working with refrigerants you must comply with all local government safety and environmental laws.

**DRAIN TRAPS**

Each drain connection requires a separate drain trap supplied and installed by the contractor. For a trap to work properly, it must be primed. During freezing periods, primed traps may need to be heat traced or drain and plug the trap when not in use. If a drain connection has a smaller pipe inside, connect to the outer pipe only. Ensure that the trap is of adequate depth to operate against a static that includes the extra pressure drop for dirty filters.

	<p><b>Warning:</b> Failure to properly trap each connection can result in drain pan flooding, standing water in unit, building damage, injury or death, cause poor air quality or other problems.</p>
---	---

In some applications (e.g. heat recovery units) there may be additional drain connections inside the curb intended to be connected to the building drainage system. These drains must be connected and properly trapped.

Cooling coil drain pans may have multiple drain connections extending outside the unit casing. Multiple drains may be connected to a common drain providing that each drain is individually trapped and vented to avoid problems from drains in different pressure zones. The drain must be properly sized and sloped.

Size drain trap with the following minimum requirements:

- a) Units With Draw Through Drain Pans:
  - H1 = Negative Static<sup>†</sup> x 1.5 + 3.5" (89mm)
  - H2 = Negative Static<sup>†</sup> x 0.75 + 2.5" (64mm)
  
- b) Units With Blow Through Drain Pans:
  - H2 = Maximum Positive Static<sup>†</sup> x 1.5
  - H1 = H2 + 0.5" (13mm)

† Static Water Column (WC) in inches or mm including fully loaded filters.

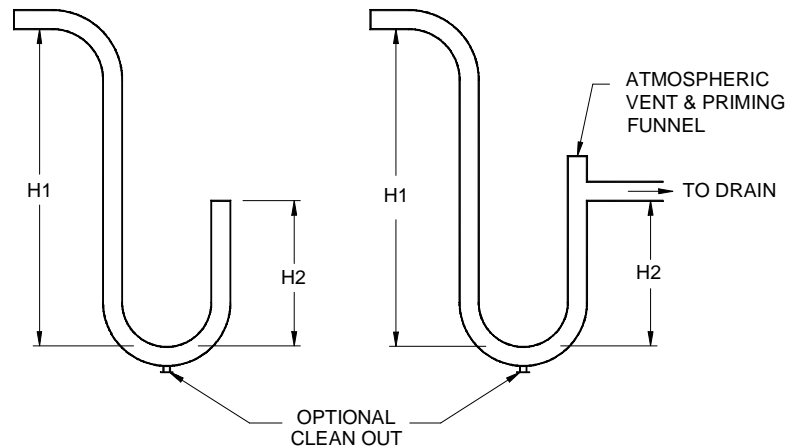

Ensure adequate clearance for properly sized drain traps.

**FLUSHING AND DEGREASING OF WATER AND GLYCOL COILS**

Coil tubing may contain material or residue from manufacturing, transportation or storage. To prevent possible damage to other components in the system, the coils must be flushed and degreased. Consult a qualified water treatment specialist.



## HEAT TRANSFER FLUIDS

The coil(s) provided have been selected for use with a specific heat transfer fluid as shown on the Submittal Record. Use of other fluids will result in different performance and can damage the coil(s).

It is imperative to properly select and apply heat transfer fluids used in heating and cooling systems. Untreated, improperly treated or improper use of fluids or use of fluids not approved for use in commercial heating and cooling systems can damage coils and system components. For selection and application of heat transfer fluids, always follow the manufacturers' recommendations including treatment, mixing and filling. Warranty will be void if coil damage results from misapplication or improper treatment of the heat transfer fluid.



Some systems may use CPVC piping. Do not use propylene glycol with CPVC.

## **BEFORE START-UP**

Remove tie-down bolts, straps and blocks on fan and compressor vibration isolators, tilt equipped heat pipes and enthalpy/desiccant wheels if supplied.

Perform a Safety Shutoff Valve Leak Test as described in this manual.

## **START-UP CHECK LIST**

 	<b>Warning: This unit is connected to high voltages. Electrical shock or death could occur if instructions are not followed. This equipment contains moving parts that can start unexpectedly. Injury or death could occur if instructions are not followed. All work should be performed by a qualified technician. Always disconnect and lock out power before servicing. DO NOT bypass any interlock or safety switches under any circumstances.</b>
--	---

The start-up and operation must be in accordance with safe practices. Start-up must be performed by qualified personnel. Complete attached start-up record.

1. Set all associated electrical switches, controls, thermostats and main disconnect switch to "OFF" position.
2. Close all manual valves and field piping valves.
3. Confirm that all shipping materials have been removed. See any supplemental instructions shipped with the unit to help identify possible locations.
4. Check all bearings, drive and fan set screws for tightness. See TABLE I
5. Check drive alignment and belt tension. Refer to Maintenance, page 25.
6. Turn disconnect switch ON (control switch is still off) and check the supply voltage. Voltage must be within 10% of rating plate. If not, contact the installing electrical contractor and have the voltage condition corrected before continuing start-up.
7. Check all fan motors for correct rotation. If incorrect, reverse rotation on incoming power only.
8. Set thermostat or controller to the "OFF" position and turn unit control switch "ON".

9. Check the amperage draw of each motor and compressor. Refer to unit or motor rating plate for full load amps. At the unit, check and record the voltage while it is running. For 3 phase power the phase to phase voltage imbalance should be less than 2%. A 2% voltage imbalance can cause up to a 10% current imbalance that will overheat motor windings.

To calculate voltage imbalance (NEMA method) refer to the following example:

Phase to phase voltage readings:	235V	236V	230V
The average Voltage between legs is	233.7V (235+236+230)/3		
Highest voltage deviation from average is:	233.7V – 230V = 3.7V		
Voltage imbalance percentage =	Highest deviation divided by average X 100		

$3.7 / 233.7 \times 100 = 1.6\%$  This imbalance is less than 2% and therefore is OK

**If voltage imbalance is greater than two percent (2%), turn off main disconnect and contact the installing electrical contractor to have the voltage condition corrected.**

10. Purge all the air from the gas (oil) lines. Refer to the Canadian Natural Gas and Propane Installation Code, C.S.A. Standard B149.1 or the National Fuel Gas Code ANSI/Z223.1/NFPA 54 for proper method. Check all connections for leaks and correct. Ensure that the inlet pressure agrees with the approval label.
11. Enable heating and/or cooling; refer to unit function for correct sequence and operation.
12. Confirm field wiring voltage drop is less than 10% when equipment is operating.
13. For the unit to operate properly a system air balance must be performed to ensure correct air flow. Failure to do so can damage the equipment and/or building and can be a cause of poor indoor air quality.
14. Damper sections:
  - a. Flat mixing dampers:  
Both the fresh air and return air dampers are fully open when the dampers are at a 45° angle when fully stroked. This provides optimum mixing of the air streams for this damper arrangement.
  - b. Angle mixing damper:  
Angle mixing section dampers open to an angle of 90° when fully stroked. This provides optimum mixing of the air streams for this damper arrangement.
15. Some units are equipped with an adjustable coil air bypass. This must be field adjusted during the system air balance to ensure proper air flow across the coil. Adjust the bypass to achieve coil pressure drop as stated on the submittal and/or the unit function sheet.
16. Check setting of fan limit control(s). Adjust high limit to value indicated below unless wiring diagram shows a different value.

High Limit	180°F	(82°C)
Fan Switch	<b>ON</b>	125°F (52°C)
	<b>OFF</b>	90°F (32°C)

17. **Set all controls to the settings indicated on the wiring diagram.**
18. Re-install all access panels.

19. Remove any packing material or debris and dispose appropriately.

## OPERATION

**Warning:** This unit is connected to high voltages. Electrical shock or death could occur if instructions are not followed. This equipment contains moving parts that can start unexpectedly. Injury or death could occur if instructions are not followed. All work should be performed by a qualified technician. Always disconnect and lock out power before servicing. **DO NOT** bypass any interlock or safety switches under any circumstances.



**Warning:** Proper commissioning and start-up of the air handling system is the responsibility of the installing contractor. It is recommended that an air balance be completed by a certified air balancing contractor to insure the air volume being delivered matches the unit rating plate. Failure to perform a proper air balance can cause injury or death, damage to the equipment, property damage, system operational problems, or be a cause of poor air quality. Moisture carry over can result from improper air flow.



This unit may incorporate one or more functions and a variety of controls and options to suit individual requirements. A description of the unit functions and options is shown on the Electrical Data Sheet and unit wiring diagram. Carefully check your wiring diagram to verify that all remote controls are properly located and correctly field wired.

Some equipment may contain programmable unitary controllers or programmable logic controllers (PLC). Additional information can be obtained from the specific programmable control manufacturer. Often this information is available from the control manufacturer's website.

**SAFETY SHUTOFF VALVE LEAK TEST:**

Safety shutoff valves require a qualified technician to perform a leak (bubble) test to determine tightness of closure on a least an annual basis. A very small amount of leakage is normal. Valve leakage rates exceeding those noted in the table below require repair or valve replacement.

1. De-energize the control system.
2. Close the upstream manual gas valve.
3. Connect a 1/4" (6mm) tube to the outlet pressure tap on the safety shutoff valve.
4. Immerse the opposite end of the 1/4" (6mm) tube (cut to a 45° angle) vertically 1/2" (13mm) into a clear container of water.
5. Count the number of bubbles appearing during a 10 second period.
6. If the bubble rate is greater than that noted in the table repair or replace the valve.
7. If bubble rate is less than noted in the table, remove the 1/4" (6mm) tube, reconnect the outlet pressure tap plug.
8. Energize the control system and open upstream manual gas valve.
9. After testing check all piping connections and plugs for external leakage.

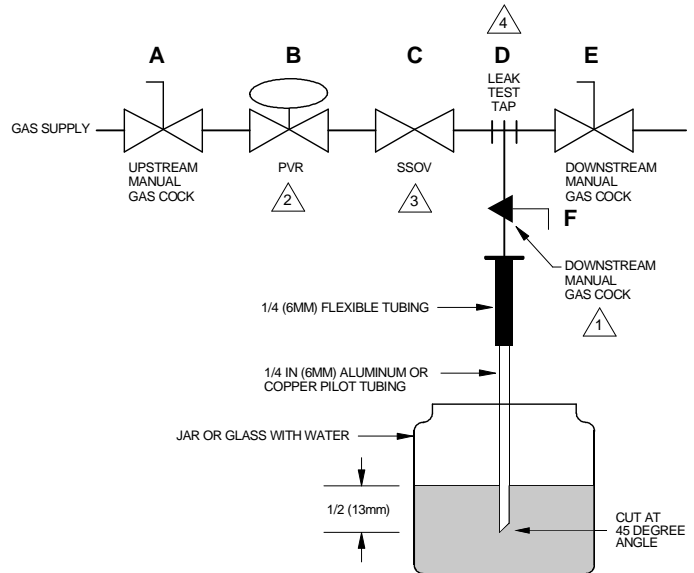

- 1 CAN ALSO BE A PERMANENT PETCOCK.
- 2 PRV = PRESSURE REGULATING VALVE.
- 3 SSOV = SAFETY SHUTOFF VALVE.
- 4 USE ONLY ONE OF THE DOWNSTREAM TAPS ON THE SSOV.

The table below indicates the maximum number of bubbles in relation to the size and type of valve.

Manufacturer	Pipe size (in.)	Model	Maximum leakage rate (bubbles/10sec.)
Honeywell	1, 1 1/4	V4943, V8943	13
	1 1/2, 2	V4943, V8943	16
	3/4, 1, 1 1/4, 1 1/2	V5055, V5097	14
	2, 2 1/2, 3	V5055, V5097	24
ASCO	3/4	K3A551/651	6
	1	K3A551/651	6
	1 1/4	K3A551/651	7
	1 1/2	K3A551/651	9

For valves not listed contact the valve manufacturer for testing procedure and acceptable leakage rate.

**GAS MANIFOLD**

It is recommended that at least once each year the safety devices should be checked. Follow operational check at detailed in this manual.

The Safety Shut Off Valves must be tested on at least an annual basis or as per the manufacturer's recommendations which ever is less.

Regulators with vent terminals must have yearly cleaning of the screen.

## OPERATIONAL CHECK FOR ALL GAS FIRED DJ & DG UNITS

The unit has been tested at the factory, gas consumption clocked, and all safety controls checked to ensure they operate. Field testing will confirm all components are operating properly after shipping and installation.

1. Read all of this section before proceeding. It may be necessary to refer to another control manual to perform some of the operation test procedure and then return to this document to complete the safety checks.
2. Do not re-light pilot or start burner when the heat exchanger is:
  - a. very hot
  - b. full of gas
3. Do not start burner unless the supply fan blower access door is secured in place and the burner access cover is firmly attached.
4. Turn the gas on for the unit. Check for leaking gas piping to the unit and check the manifold piping up to the safety shutoff valves.
5. Check the main and safety shut off valves and pilot valve for leakage following the valve manufacture's recommendations.
6. Turn on the manual pilot valve.
7. At this point if your unit has one of the DJM, DJT, G-TRAC, X-TRAC, etc. CONTROLS refer to its manual as to how to force it to call for fire, modulate the flame, set up combustion etc. If your unit does not have one these controls then follow the next few steps.
8. Set the temperature control at the highest setting to call for heat. Units with no DJM, DJT, G-TRAC, X-TRAC CONTROLS are usually single stage or two stage units operated from simple duct and / or room thermostats.
9. The combustion burner motor should start and the unit will be in a pre-purge mode. When the combustion burner motor is in operation the air switch should close as proof of air flow. The time of the pre-purge will vary depending on the size of the heat exchanger (Usually 30 seconds on mid size units and up to 7 minutes on large units).
10. When the purge time expires then the ignition control is energised. There is a 8-15 second trial for ignition to light the pilot depending on the type of unit and type of ignition control.
11. Confirm the pilot, then open the manual valve for the main burner.
12. With power supplied to the ignition controller, the pilot gas valve is energized and the igniter lights the pilot. When the sensing probe proves the pilot flame, it de-energizes the spark igniter and energizes the main gas valve. See the internal wiring diagram for the type of flame ignition control used.
13. Confirm gas inlet pressure matches unit rating plate at high fire. The appliance regulator shall be adjusted to provide the manifold pressure specified on the rating plate.

14. Check combustion as described in combustion and final checkout section (or if the unit contains DJM, DJT, G-TRAC, X-TRAC, DSTRAC etc. CONTROLS refer to those manuals for proper setup).
15. Once the heat call is satisfied:
  - a. Ignition controller de-energized.
  - b. Main gas valve de-energized.
16. Units with M420, M520 and M620 or MR610 modulating gas valves that are vented to the burner box must have the adjustment cover sealed tight so that the valve will respond properly. Do not leave cover off after making adjustments. (This is referred to as "top loading" and allows the valve to respond to the pressure in the burner box).
17. After the combustion has been checked, bring the unit to high fire and check entire manifold for gas leaks.
18. Adjust airflow through the unit to obtain the rating plate specified airflow.
19. Do a final check of the main and safety shutoff valves and pilot valve for leakage following the valve manufacturer's recommendations.

#### OPERATIONAL CHECK FOR ALL OIL FIRED DJ & DG UNITS

Ensure all oil piping is installed correctly, is clean, is leak free and has a full oil line.

1. Read all of this section and the supplemental information bulletin from the burner manufacturer before proceeding. It may be necessary to refer to another control manual to perform some of the operation test procedure and then return to this document to complete the safety checks.
2. Do not start burner when the heat exchanger is:
  - a. very hot
  - b. has oil laying in the bottom.
3. Close the main shut-off valve, turn the burner switch off, set controller to call for heat, turn the burner switch on. The flame ignition control will energize the ignition transformer and solenoid valve after the pre-purge timing is complete. After the trial for ignition time, the flame ignition control will de-energize the ignition transformer and solenoid valve and will lock out.
4. Do not start burner unless the supply fan blower access door is secured in place and the burner
5. Open the shut-off valve. Reset the flame ignition control. After the pre-purge, the ignition transformer and the pilot solenoid valve are energized. Observe the ignition spark for location and stability. Check flame signal and if necessary, adjust the oil pressure to obtain a stable flame with the highest steady flame signal. (See separate burner and flame ignition control manuals).
6. Perform a combustion smoke test with unit operating at high fire. Adjust burner if smoke spot test is 3 or higher on ASTM D 2156-63T.
7. Observe the flame and insure that the flame does not impinge on the heat exchanger surface and that there are no hot spots on the combustion chamber.

COMBUSTION AND FINAL UNIT CHECK FOR UNITS WITHOUT TRAC CONTROLS

The heater has been test fired in the factory for firing rate and combustion. Field conditions may require small adjustments to be made. These checks should be done by a qualified service man.

1. When the main flame is established, check the gas manifold pressure at the test point nearest the burner with the unit operating at high fire. Check the name plate for the correct manifold pressure and adjust the appliance regulator if necessary. The unit inlet gas pressure should not go below the minimum pressure shown on the nameplate when at high fire. Ensure that the temperature rise does not exceed nameplate.
2. Check CO and O<sub>2</sub> reading at maximum and minimum inputs shown on name plate. CO should generally not be above 200 ppm and a very maximum of 300 ppm. O<sub>2</sub> reading should range from 3 1/2% to 4% at high fire on all units. Low fire combustion values are found on the table below for units that have constant combustion air or variable combustion air damper.

Model of Unit	Type of burner	Shape of burner	Low Fire % of max	O <sub>2</sub> Reading
DJ w/ Constant Combustion Air	Standard	Round	60%	10 –11.5%
DG	Model B or R Gorden Piatt	Round (painted blue)	50%	10%

For units with G-TRAC, G-TRAC2, DJM, DJM-2, DJM-3 and X-TRAC controllers refer to Combustion Set-Up section in the Installation, Operation and Maintenance Manuals for the respective controls.

3. Check flue outlet pressure on indoor unit to make sure that it does not exceed the maximum shown on the nameplate. (See maximum overfire pressure).
4. When the unit start up is complete, re-check the amperage draw of each motor (i.e., after an air balance).
5. Ensure that the safety controls are operative, i.e., flame ignition control, high limit, etc. (See specification sheets on all controls). Recheck setting of all limits and temperature controls.

**ELECTRODE DETAIL**

The spark gap is 1/8" (3 mm). Ensure that there is a gasket between the electrode assembly and pilot box housing.

High Turndown (Rectangular) Burner

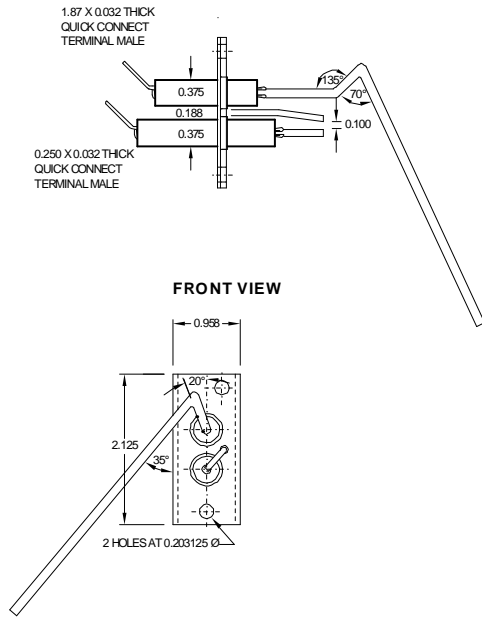

Standard (Round) Burner

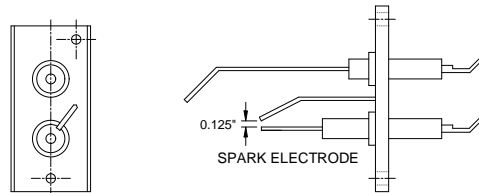

**UNIT SHUT-DOWN INSTRUCTIONS**

**Service Shut Down**

1. Set the thermostat in the "OFF" position.
2. Close the manual firing valve in the manifold on gas fired heaters or the manual oil valve on oil fired heaters.
3. If the unit was firing at the time of shut down allow the main blower to run for a sufficient period to cool off the heat exchanger.
4. Set the unit "ON-OFF" toggle switch to the "OFF" position.
5. Set the main power disconnect switch to the "OFF" position.

**⚠ CAUTION:** If the unit is to be off for an extended period of time, close the manual shut off valve.



## Emergency Shut Down

1. Set the electrical disconnect switch to the “OFF” position.
2. Close the main manual firing valve in the manifold on gas fired heaters, or the manual oil valve on oil fired heaters.

## Start-Up After Extended Shut-Down Period

When unit is shut down for an extended period of time the same start-up procedures, as outlined in previous sections, should be followed.

## CONTROL SETTINGS

The following settings of the adjustable controls are acceptable for most applications. Refer to unit function and wiring diagram for settings specific to your unit.

Single and two stage ductstat: 55 – 70°F (13 – 21°C).

Single, two stage and modulating space thermostat: 68 – 74°F (20 – 23°C).

Remote temperature selector: 60 – 70°F (16 – 21°C).

Mixed air temperature controller: 55°F (13°C).

Low discharge air limit: 40°F (5°C).

Ambient control: 50 – 70°F (10 – 21°C).

Economizer ambient changeover control: 70 – 75°F (21 – 24°C).

## MAINTENANCE

**Warning:** This unit is connected to high voltages. Electrical shock or death could occur if instructions are not followed. This equipment contains moving parts that can start unexpectedly. Injury or death could occur if instructions are not followed. All work should be performed by a qualified technician. Always disconnect and lock out power before servicing. DO NOT bypass any interlock or safety switches under any circumstances.



**Warning:** Follow the cleaning instructions and recommended inspection schedule to reduce the risk of mold or other bacterial growth. Property damage or personal injury claims may result from mold or biological growth arising from improper installation, inadequate maintenance, or failure to inspect. Engineered Air has no responsibility for and makes no express or implied warranties regarding mold or bacterial growth or any other indoor air quality issues. If mold or biological growth is present, determine and fix the cause. Properly remove and dispose of the contamination. Properly clean and sanitize the affected area using only approved sanitizers suitable for HVAC equipment.



To provide a maintenance history, It is recommended that the owner have a maintenance file for each unit. **The following maintenance instructions are to be carried out each spring and fall or as otherwise indicated by qualified service personnel.**

**Caution:**



**Label all wires prior to removal when servicing controls or critical components. Wiring errors can cause improper and dangerous operation.**



**Verify proper operation after servicing.**

## ELECTRICAL

1. Check all wiring for loose connections.
2. Check voltage at unit (while in operation).
3. Check amperage draw against unit rating plate.
4. Where possible, all contactors should be inspected to ensure that contacts are clean and are making good contact. If contacts are abnormally pitted or burned badly, replace contactor. Single phasing and motor burnouts can result from bad contacts.

## BELT ADJUSTMENT

For maximum belt and bearing life, pulley alignment and belt tension must be properly maintained. Only replace with belts of the proper type and size.

NOTE: If belts are too tight or improperly aligned, the life expectancy of the motor(s), fan bearings and belt(s) are reduced.

Alignment: Pulleys must be aligned to within 1/16" per foot (1mm per 760mm) of span.

### **FOR FANS EQUIPPED WITH SPIDER BRACKETS:**

A properly adjusted V-belt rides the inside of the pulley faces. Because the sides of the belt wedge in the pulleys, the V-belt does not have to be extremely tight. It should be as loose as possible without slipping in the pulley grooves.

Belt deflection: 3/4 " (19mm) for each foot (300mm) of span between the pulleys.

### **FOR FANS EQUIPPED WITH PILLOW BLOCK BEARINGS:**

Belt Deflection: Allow 1/64" (0.4mm) of deflection for each 1" (25.4 mm) of span length.

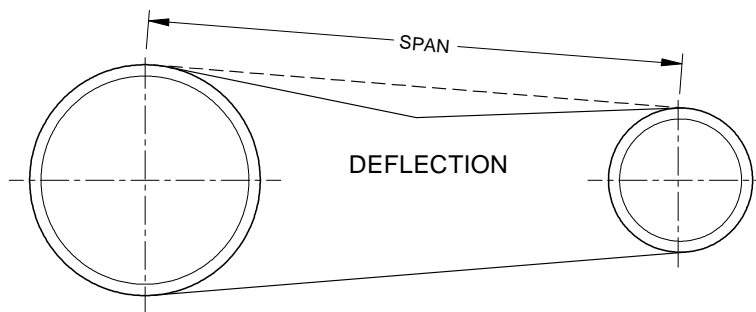

**⚠ CAUTION:** Excessive belt tension is the most frequent cause of belt wear, bearing wear and noise.

**SET SCREWS**

Check set screws on fan wheel, fan bearings, fan and motor pulleys for looseness on the shaft. Tighten where required. **IT IS IMPORTANT TO PERFORM THIS CHECK BEFORE INITIAL START-UP, AFTER A RUN-IN PERIOD OF 2 WEEKS AND THEN ON 4 MONTH INTERVALS.**

**⚠ CAUTION: OVERTIGHTENING SET SCREWS CAN DAMAGE BEARINGS.**

**BEARING SETSCREW TORQUES**

Shaft diameter	NTN	KOYO	NTN	KOYO	DODGE
Type	UC SERIES (set screw)		UK SERIES (adapter sleeve locknut)		SC 203-215 SERIES
3/4" (19mm)	35 in-lb (3.9 Nm)	35 in-lb (4.0 Nm)	Install the washer and lock nut; tighten the nut fully by hand.  Apply a punch or screw driver into the notch of the nut and tap it with a hammer. Stop tapping after the nut has turned 60° to 90°. Do not strike the seal.  Bend the tab on the rim of the washer, which is in line with the notch of the nut.  If a tab does no line up with a notch, tighten the nut further. <b>DO NOT BACK THE NUT OFF.</b>		66 - 80 in-lb (7.5 - 9 Nm)
1" (25mm)	35 in-lb (3.9 Nm)	35 in-lb (4.0 Nm)		126 - 156 in-lb (14 -18 Nm)	
1 3/16" (30mm)	43 in-lb (4.9 Nm)	35 in-lb (4.0 Nm)		126 - 156 in-lb (14 -18 Nm)	
1 7/16" (37mm)	51 in-lb (5.8 Nm)	75 in-lb (8.5 Nm)		126 - 156 in-lb (14 -18 Nm)	
1 11/16"(43mm)	69 in-lb (7.8 Nm)	75 in-lb (8.5 Nm)		228 -272 in-lb (26 -31 Nm)	
1 15/16"(49mm)	69 in-lb (7.8 Nm)	155 in-lb (17.5 Nm)		228 -272 in-lb (26 -31 Nm)	
2 3/16"(56mm)	87 in-lb (9.8 Nm)	155 in-lb (17.5 Nm)		228 -272 in-lb (26 -31 Nm)	
2 7/16"(62mm)	147 in-lb (16.6 Nm)	155 in-lb (17.5 Nm)		228 -272 in-lb (26 -31 Nm)	
2 11/16"(68mm)	173 in-lb (19.6 Nm)	248 in-lb (28.0 Nm)		228 -272 in-lb (26 -31 Nm)	
2 15/16"(75mm)	173 in-lb (19.6 Nm)	248 in-lb (28.0 Nm)		228 -272 in-lb (26 -31 Nm)	

Refer to bearing manufacturers' literature for all other types of bearings.

**LUBRICATION OF FAN BEARINGS**

Some fans have permanently lubricated sealed ball bearings which should not require lubrication. These bearings are factory packed 30 to 50% full. **Bearings that require lubrication should be greased while the bearing is rotating slowly, with the following quantities of a lithium base lubricant. DO NOT OVERGREASE. DO NOT USE NON-LITHIUM BASED GREASE.**

Extended lubrication lines may be provided. Tubing is not factory filled.

**RECOMMENDATIONS FOR BALL BEARINGS**

Bearing Temperature ° F (°C)	Re-Greasing Interval		
	Clean	Dusty	Dusty & Wet
Under 120 (50)	2 ½ Years	Yearly	4 Months
Under 158 (70)	Yearly	4 Months	1 Month

Shaft Dia.	3/4" (19mm)	1" (25mm)	1 3/16" (30mm)	1 7/16" (37mm)	1 11/16" (43mm)	1 15/16" (49mm)	2 7/16" (62mm)	2 15/16" (75mm)
Grease	0.06 oz. (1.8g)	0.12 oz. (3.3g)	0.20 oz. (5.6g)	0.23 oz. (6.5g)	0.27 oz. (7.7g)	0.36 oz. (10.3g)	0.53 oz. (14.9g)	1.00 oz. (31.0g)

For additional information refer to the fan and/or bearing manufacturers' literature.

### LUBRICATION OF DODGE FAN BEARINGS

#### **Suggested Re-lubrication Schedule (Months)\* for Dodge Ball Bearing Pillow Block**

Speed (RPM)	500	1000	1500	2000	2500	3000	3500	4000	4500
Shaft DIA.									
1/2" - 1 1/16"	6	6	5	3	3	2	2	2	1
1 15/16" - 2 7/16"	6	5	4	2	2	1	1	1	1
2 11/16" - 2 5/16"	5	4	3	2	1	1	1		
3 7/16" - 3 15/16"	4	3	2	1	1				

\* Suggested initial greasing interval. . If safety permits, re-lubricate while running until some purging occurs at seals. Adjust lubrication frequency depending on condition of purged grease. Hours of operation, temperature and surrounding conditions will affect the re-lubrication frequency required. For 24 hour operation double the lubrication frequency.

Lubricate with a multipurpose NLGI No. 2 or No. 3 ball bearing grease having rust inhibitors, antioxidant additives and a minimum viscosity of 500 SSU at 100°F (38°C). Some examples of grease having these properties are:

Shell	Alvania RL 2
Mobil	Mobilith SHC220
Exxon	Ronex MP

Lubricate bearings prior to extended shutdown or storage and rotate shaft monthly to aid corrosion protection.

#### **Suggested Re-lubrication Schedule (Months)\* for Dodge Spherical Roller Bearing - Solid Pillow Block**

Speed (RPM)	500	1000	1500	2000	2500	3000	3500	4000	4500
Shaft DIA.									
1 3/16" - 1 7/16"	6	4	4	2	1	1	1	1	1/2
1 11/16" - 2 3/16"	4	2	1 1/2	1	1/2	1/2	1/2	1/2	1/2
2 7/16" - 3 7/16"	3	1 1/2	1	1/2	1/2	1/4	1/4		
3 15/16" - 4 15/16"	2 1/2	1	1/2	1/4					

\* Suggested initial greasing interval. If safety permits, re-lubricate while running until some purging occurs at seals. Adjust lubrication frequency depending on condition of purged grease. Hours of operation, temperature and surrounding conditions will affect the re-lubrication frequency required. For 24 hour operation double the lubrication frequency.

Lubricate with a multipurpose roller bearing NLGI No. 2 having rust inhibitors and antioxidant additives, and a minimum oil viscosity of 500 SSU at 100°F. Some examples of grease having these properties are:

Shell	Alvania No. 2
Mobil	Mobilith AW2 Mobilith SHC100
Texaco	Premium RB2
American	Rykon Premium 2

Lubricate bearings prior to extended shutdown or storage and rotate shaft monthly to aid corrosion protection.

**Suggested Re-lubrication Schedule (Months)\* for Dodge Spherical Roller Bearing – Split Pillow Blocks**

Speed (RPM)	500	750	1000	1500	2000	2500	3000	3500	4000	** oz.
Shaft DIA.										
1 <sup>7</sup> / <sub>16</sub> " – 1 <sup>15</sup> / <sub>16</sub> "	6	4 <sup>1</sup> / <sub>2</sub>	4	4	3 <sup>1</sup> / <sub>2</sub>	2 <sup>1</sup> / <sub>2</sub>	2 <sup>1</sup> / <sub>2</sub>	1	1	0.05
2 <sup>3</sup> / <sub>16</sub> " – 2 <sup>11</sup> / <sub>16</sub> "	5	4 <sup>1</sup> / <sub>2</sub>	4	2 <sup>1</sup> / <sub>2</sub>	2 <sup>1</sup> / <sub>2</sub>	1 <sup>1</sup> / <sub>2</sub>	<sup>1</sup> / <sub>2</sub>	<sup>1</sup> / <sub>4</sub>	<sup>1</sup> / <sub>4</sub>	0.75
2 <sup>15</sup> / <sub>16</sub> " – 3 <sup>15</sup> / <sub>16</sub> "	4 <sup>1</sup> / <sub>2</sub>	4	3 <sup>1</sup> / <sub>2</sub>	2 <sup>1</sup> / <sub>2</sub>	1 <sup>1</sup> / <sub>2</sub>	1	<sup>1</sup> / <sub>2</sub>			2.00
4 <sup>7</sup> / <sub>16</sub> " – 4 <sup>15</sup> / <sub>16</sub> "	4	4	2 <sup>1</sup> / <sub>2</sub>	1	<sup>1</sup> / <sub>2</sub>					4.00
5 <sup>7</sup> / <sub>16</sub> " – 5 <sup>15</sup> / <sub>16</sub> "	4	2 <sup>1</sup> / <sub>2</sub>	1 <sup>1</sup> / <sub>2</sub>	1						7.00

\* Suggested initial greasing interval. Remove bearing cap and observe condition of used grease. Adjust lubrication frequency as needed. Hours of operation, temperature and surrounding conditions will affect the re-lubrication frequency required. Clean and repack bearing annually. Remove old grease, pack bearing full and fill housing reservoirs on both sides of bearing to bottom of shaft. For 24 hour operation double the lubrication frequency.

\*\* Grease to be added at each interval.

Lubricate with a multipurpose roller bearing NLGI No. 2 having rust inhibitors and antioxidant additives, and a minimum oil viscosity of 500 SSU at 100°F. Some examples of grease having these properties are:

Shell	Alvania No. 2
Mobil	Mobilith AW2 Mobilith SHC100
Texaco	Premium RB2
American	Rykon Premium 2

Lubricate bearings prior to extended shutdown or storage and rotate shaft monthly to aid corrosion protection.

### Static Oil Lubrication

Use only highest quality mineral oil with a minimum viscosity of 100 SSU at the oil's operating temperature. The oil's operating temperature is approximately 10°F greater than the bearing's housing. SAE values having this viscosity at the following operating temperature are:

150° - SAE 20      160° - SAE 30      180° - SAE 40

Static oil level should be at the center of the lower-most roller (do not overfill).

Complete lubrication change should be made annually.

### MOTOR LUBRICATION

Refer to motor manufacturer for lubrication recommendations.

On motors having grease drain plugs, remove the plugs and operate the motor for 15 minutes before replacing plugs. **DO NOT OVER GREASE.**

## RECOMMENDED MOTOR LUBRICATION INTERVALS

Hours Service Per Day	Up to 7.5 HP Up to 5.6 kW	10 to 40 HP 7.5 to 29.8 kW	Over 40 HP Over 29.8 kW
Less than 12	5 Years	3 Years	1.5 Years
More than 12	2 Years	1 Year	9 Months

NOTE: Motors that run in severe conditions should be greased as specified by the motor manufacturer.

## GAS MANIFOLD

It is recommended that at least once each year the safety devices should be checked. Follow operational check at detailed in this manual.

The Safety Shut Off Valves must be tested on at least an annual basis or as per the manufacturer's recommendations which ever is less.

Regulators with vent terminals must have yearly cleaning of the screen.

## GAS BURNERS

It is recommended that the burner be inspected once each year. Remove any scale that may have accumulated on the burner plates. Ensure that the holes on the burner plates and gas orifices are completely clear of foreign material. All casting orifices on straight burners are #42.

## OIL BURNERS

It is recommended that the oil burner be inspected and cleaned at least once each year. Refer to the supplemental information bulletin from the burner manufacturer included with the unit.

## VENT TERMINALS

The vent terminal should be checked and cleaned every fall. If the terminal is found to have accumulations of leaves or other debris, clean more often as necessary.

## FILTERS

Filter-changing intervals can be based on the pressure drop across the filter or by calendar scheduling or visual inspection. Scheduled intervals should be between one and six months, depending on the pollutant loading from indoor and outdoor air. More-frequent changes may be required during the economizer season.

**Units that operate with high levels of outside air should have filters removed (or moved to winter filter location if available) during the winter months in areas that have heavy frost or snow.**

Plugged or excessively dirty filters can cause damage to the equipment. See submittal record for filter quantities, sizes and types. Use same size and type for replacement.

- A. High Velocity Permanent:  
It is important that the filters be checked and cleaned regularly during the period immediately

following installation, in order to determine the best service interval. To clean, rinse with water. Shake off excess water and re-install. These filters do not require an oil adhesive.

- B. Pleated Throwaway and/or Replaceable Media (Cartridge, Bag):  
Replacement filters can be obtained from any Engineered Air representative.

In some applications the used filters/media may contain chemical or biological hazards. All local, regional and national regulations for safety and disposal should always be followed.

## CONTROLS

Annually clean and recalibrate all controls, check for proper operation, and repair or replace any faulty controls. Check all damper hardware settings every three months. Replace blown fuses with equivalent size and type fuse. Failure to do so can result in damage to the unit.

## CONTROL ENCLOSURE VENTILATION

Control enclosures are often ventilated in summer to provide component cooling. A manually adjustable slide damper is provided for adjustment and seasonal shut off. The slide damper should be closed for winter operation and opened for summer operation.

## OUTDOOR AIR INTAKES, MIXING SECTIONS AND DAMPERS

Outdoor air intakes, screens, and adjacent areas shall be checked semi-annually for cleanliness, integrity and proper operation. Adjust dampers where required.

## COILS

Inspect coils and drain pans for cleanliness and biological growth once per year during the cooling season or more often as required.

### **Warning:**



**Dirty coils can be a cause of poor air quality. Failure to maintain clean coils can cause injury or death, damage to the equipment, property damage or system operational problems. Moisture carry over can result from dirty coils.**

The external surface of finned coils can be cleaned using a low pressure water spray and a brush. Coil fins are easily damaged. Do not use high pressure steam or water to clean coils; it will permanently damage the coil. When using cleaning additives or solutions they must be compatible with the coil materials or coatings. Use a fin comb to straighten any damaged or bent fins.

### Coil Winterization:

Water coils that are not in use must be protected from freezing. Coils should be drained and blown out with compressed air and then filled and drained several times with appropriate strength pre-mixed inhibited HVAC glycol or other suitable fluid. Do not use propylene glycol with CPVC piping.









